

IEC Appliance Inlet C8 with Filter, Front Side Mounting



Snap-in mounting from front side

Screw-on mounting from front side



Approvals and Compliances

Description

- Panel Mount :
Screw-on or snap-in mounting from front side
- 2 Functions :
Appliance Inlet Protection class II , Line filter in standard and medical version
- Solder terminals or quick connect terminals

Characteristics

- Compact high performance filter
- Suitable for use in equipment according to IEC/UL 60950
Suitable for use in medical equipment according to IEC/UL 60601-1

Other versions on request

- Standard version without X-capacitor
- Polarized C8 connector

References

Alternative: version without line filter [2576](#); [2578](#)

Weblinks

[pdf datasheet](#), [html-datasheet](#), [General Product Information](#), [Distributor-Stock-Check](#), [Accessories](#), [Detailed request for product](#)

Technical Data

Ratings IEC	0.5 - 2.5A @ Ta 40 °C / 250VAC; 50Hz
Ratings UL/CSA	0.5 - 6A @ Ta 40 °C / 250VAC; 60Hz
Dielectric Strength	> 1.7kVDC between L-N > 4kVDC between L/N-PE Test voltage (2 sec)
Impulse Withstand Voltage	> 2.5kV between L-N
Allowable Operation Temperature	-25 °C to 85 °C
Climatic Category	25/085/21 acc. to IEC 60068-1
IP-Protection	from front side IP 40 acc. to IEC 60529
Protection Class	Suitable for appliances with protection class II acc. to IEC 61140
Terminal	solder pin or quick connect terminals 6.3 x 0.8 or 4.8 x 0.8 mm
Panel Thickness S	Screw Mounting screw torque max 0.5Nm Snap-in 1 mm to 3 mm
Material: Housing	Thermoplastic, black, UL 94V-0

appliance inlet/-outlet	C8 acc. to IEC 60320-1 UL 498, CSA C22.2 no. 42 (for cold conditions) pin-temperature 70 °C, 2.5A, Protection Class II
Line Filter	Standard and Medical Version, IEC 60939, UL 1283, CSA C22.2 no. 8 Technical Details
MTBF	> 6'700'000h acc. to MIL-HB-217 F

Approvals and Compliances

Detailed information on product approvals, code requirements, usage instructions and detailed test conditions can be looked up in [Details about Approvals](#)

Approvals









The approval mark is used by the testing authorities to certify compliance with the safety requirements placed on electronic products.

Approval Reference Type: 5008

Approval Logo	Certificates	Certification Body	Description
	VDE Approvals	VDE	Certificate Number: 40029278
	UL Approvals	UL	UL File Number: E72928



Product standards

Product standards that are referenced

Organization	Design	Standard	Description
	Designed according to	IEC 60320-1	Appliance couplers for household and similar general purposes
	Designed according to	IEC 60939	Passive filters for suppressing electromagnetic interference
	Designed according to	IEC 60127-6	Miniature fuses. Part 6. Fuse-holders for miniature fuse-links
	Designed according to	IEC 61058-1	Switches for appliances. Part 1. General requirements
	Designed according to	UL 498	Standard for Attachment Plugs and Receptacles
	Designed according to	UL 1283	Electromagnetic interference filters
	Designed according to	CSA C22.2 no. 42	General Use Receptacles, Attachment Plugs, and Similar Wiring Devices
	Designed according to	CSA C22.2 no. 8	Electromagnetic interference (EMI) filters





Application standards

Application standards where the product can be used

Organization	Design	Standard	Description
	Designed for applications acc.	IEC/UL 60950	IEC 60950-1 includes the basic requirements for the safety of information technology equipment.
	Designed for applications acc.	IEC 60601-1	Medical electrical equipment - Part 1: General requirements for basic safety and essential performance

Compliances

The product complies with following Guide Lines

Identification	Details	Initiator	Description
	CE declaration of conformity	SCHURTER AG	The CE marking declares that the product complies with the applicable requirements laid down in the harmonisation of Community legislation on its affixing in accordance with EU Regulation 765/2008.
	RoHS	SCHURTER AG	EU Directive RoHS 2011/65/EU
	China RoHS	SCHURTER AG	The law SJ / T 11363-2006 (China RoHS) has been in force since 1 March 2007. It is similar to the EU directive RoHS.
	REACH	SCHURTER AG	On 1 June 2007, Regulation (EC) No 1907/2006 on the Registration, Evaluation, Authorization and Restriction of Chemicals 1 (abbreviated as "REACH") entered into force.
	Medical Equipment	SCHURTER AG	Suitable for use in medical equipment according to IEC/UL 60601-1

Dimension [mm]

Screw-on mounting from front side

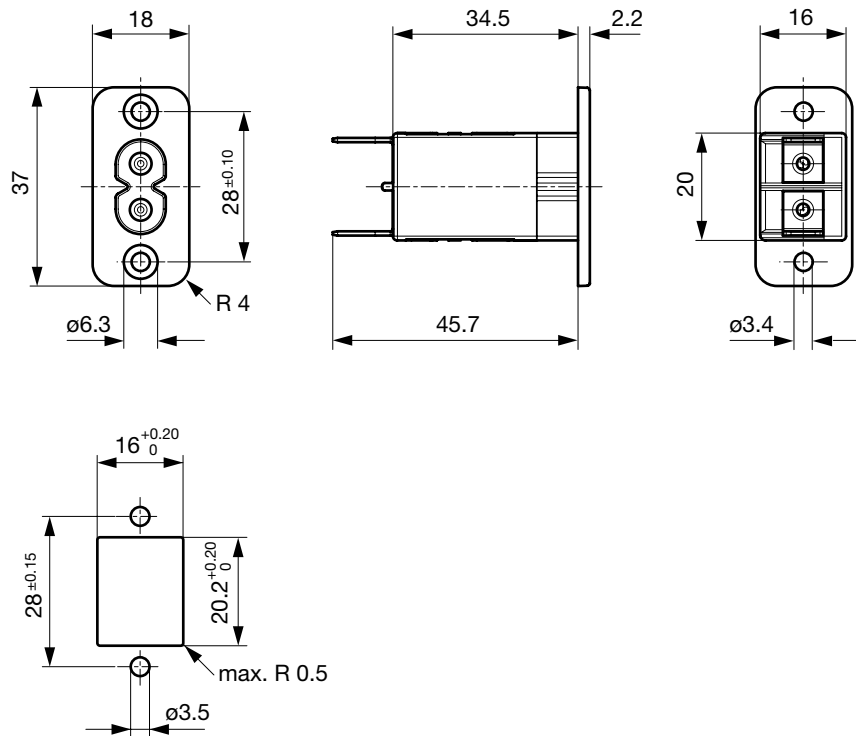

Snap-in mounting from front side

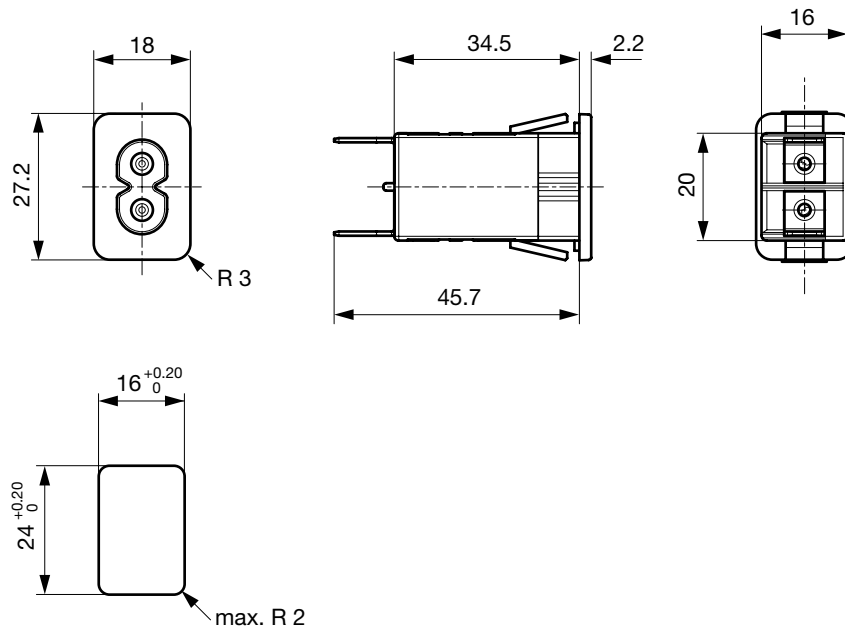

Technical Data of Filter-Components

Rated Current [A]	Filter-Type	Inductances L [mH]	Capacitance CX [nF]	Capacitance CY [nF]	R [MΩ]
1	Standard Version without Cx	2 x 8	-	-	-
0.5	Standard Version	2 x 18	100	-	-
1	Standard Version	2 x 8	100	-	-
2.5	Standard Version	2 x 1.2	100	-	-
4	Standard Version	2 x 0.8	100	-	-
6	Standard Version	2 x 0.3	100	-	-
0.5	Medical Version (M5)	2 x 18	100	-	1
1	Medical Version (M5)	2 x 8	100	-	1
2.5	Medical Version (M5)	2 x 1.2	100	-	1
4	Medical Version (M5)	2 x 0.8	100	-	1
6	Medical Version (M5)	2 x 0.3	100	-	1

Diagrams

Standard version

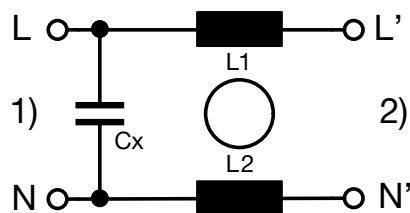

1) Line
2) Load

Medical version M5

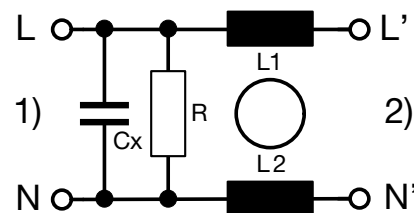

1) Line
2) Load

Derating Curves

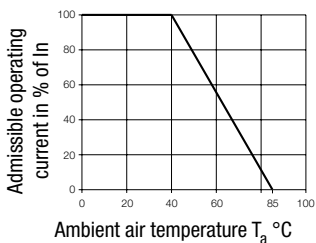

Attenuation Loss

----- 50Ω differential mode _____ 50Ω common mode

Standard version

0.5 A

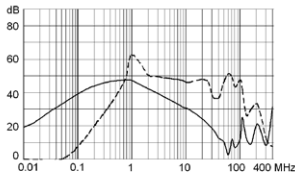

1 A

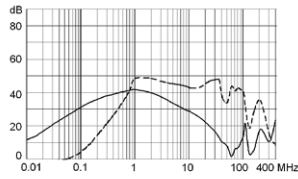

2.5 A

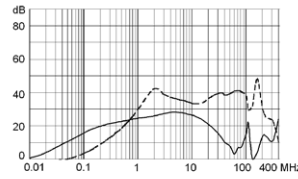

4 A

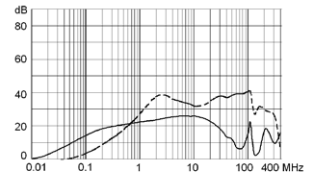

6 A

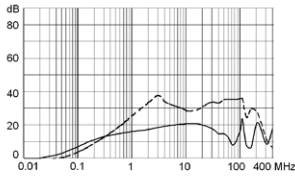

Medical version (M5)

0.5 A

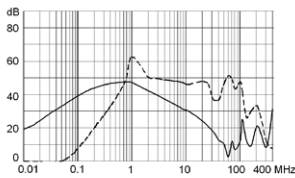

1 A

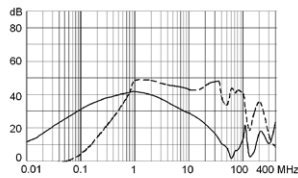

2.5 A

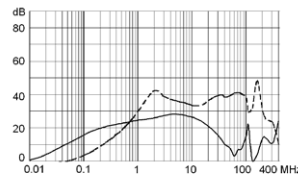

4 A

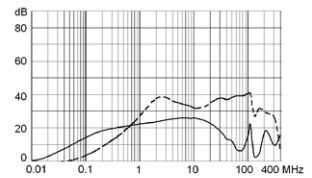

6 A

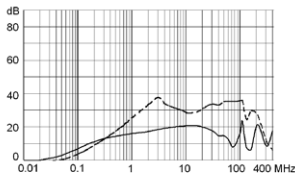

All Variants

Rated Current [A]	Filter-Type	Mounting	Terminal	Order Number
1	Standard Version without Cx	Snap-in 1.5	Quick connect terminal 4.8 x 0.8 mm	5008.2211
0.5	Standard Version	Snap-in 1.0	Quick connect terminal 4.8 x 0.8 mm	5008.1010
0.5	Standard Version	Snap-in 1.5	Quick connect terminal 4.8 x 0.8 mm	5008.2010
1	Standard Version	Snap-in 1.5	Solder terminal	5008.2021
1	Standard Version	Snap-in 1.5	Quick connect terminal 6.3 x 0.8 mm	5008.2001
1	Standard Version	Snap-in 2.0	Quick connect terminal 4.8 x 0.8 mm	5008.3011
2.5	Standard Version	Screw	Solder terminal	5008.0022
2.5	Standard Version	Screw	Quick connect terminal 6.3 x 0.8 mm	5008.0002
2.5	Standard Version	Screw	Quick connect terminal 4.8 x 0.8 mm	5008.0012
2.5	Standard Version	Snap-in 1.0	Quick connect terminal 4.8 x 0.8 mm	5008.1012
2.5	Standard Version	Snap-in 1.5	Solder terminal	5008.2022
2.5	Standard Version	Snap-in 1.5	Quick connect terminal 4.8 x 0.8 mm	5008.2012
2.5	Standard Version	Snap-in 2.0	Solder terminal	5008.3022
2.5	Standard Version	Snap-in 2.0	Quick connect terminal 6.3 x 0.8 mm	5008.3002

Rated Current [A]	Filter-Type	Mounting	Terminal	Order Number
4	Standard Version	Snap-in 1.5	Quick connect terminal 4.8 x 0.8 mm	5008.2014
6	Standard Version	Screw	Quick connect terminal 6.3 x 0.8 mm	5008.0006
6	Standard Version	Snap-in 1.0	Quick connect terminal 4.8 x 0.8 mm	5008.1016
6	Standard Version	Snap-in 1.5	Quick connect terminal 4.8 x 0.8 mm	5008.2016
0.5	Medical Version (M5)	Snap-in 1.0	Quick connect terminal 4.8 x 0.8 mm	5008.1110
1	Medical Version (M5)	Screw	Quick connect terminal 4.8 x 0.8 mm	5008.0111
1	Medical Version (M5)	Snap-in 1.0	Quick connect terminal 4.8 x 0.8 mm	5008.1111
1	Medical Version (M5)	Snap-in 2.0	Quick connect terminal 4.8 x 0.8 mm	5008.3111
2.5	Medical Version (M5)	Snap-in 1.0	Quick connect terminal 4.8 x 0.8 mm	5008.1112
2.5	Medical Version (M5)	Snap-in 2.0	Quick connect terminal 6.3 x 0.8 mm	5008.3102
4	Medical Version (M5)	Snap-in 1.0	Quick connect terminal 4.8 x 0.8 mm	5008.1114
4	Medical Version (M5)	Snap-in 1.5	Quick connect terminal 4.8 x 0.8 mm	5008.2114
6	Medical Version (M5)	Snap-in 1.0	Quick connect terminal 4.8 x 0.8 mm	5008.1116
6	Medical Version (M5)	Snap-in 1.5	Quick connect terminal 4.8 x 0.8 mm	5008.2116

Availability for all products can be searched real-time: <https://www.schurter.com/en/Stock-Check/Stock-Check-SCHURTER>

Packaging unit 20 Pcs

Mating Outlets/Connectors

Category / Description

Power Cord Overview complete



Cord Sets 2.5 A, IEC Connector, Black, 2.0 m, H03VWH2-F 2x0,75mm², Connector IEC C7, 001500 mm, H03VWH2-F2G0.75, black

6013.0474

Cord Sets 2.5 A, IEC Connector, Black, 4.0 m, H03VWH2-F 2x0,75mm², Connector IEC C7, 001500 mm, H05VWH2-F2G0.75, black

6013.0478

[Power Cord further types to 5008](#)

Power Supply Cord Overview complete



Cord Sets 2.5 A, North America, Black, 2.0 m, SVT 2x18AWG, Connector IEC C7, 002500 mm, NISPT-2, black

6010.5274

Cord Sets 2.5 A, North America, Black, 4.0 m, SVT 2x18AWG, Connector IEC C7, 002500 mm, NISPT-2, black

6010.5278

[Power Supply Cord further types to 5008](#)